

MOULD COOLING COUPLINGS

KÜHLUNGSELEMENTE FÜR WERKZEUGE

# SERIE 102



## FLAT FACE WATER SERIE

---

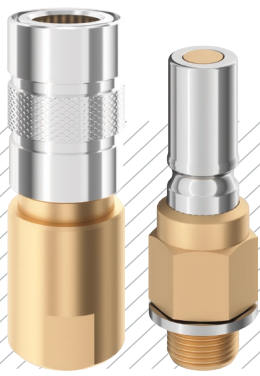

MOULD COOLING COUPLINGS  
KÜHLUNGSELEMENTE FÜR WERKZEUGE

# DN 6-12

## SERIE 102

**Materials**

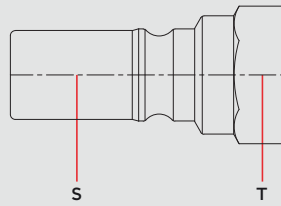
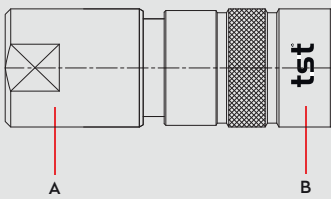

**Material Code**

A = Brass

B = AISI 420 / Chrome Plated

S = AISI 420

T = Brass

0 - 50 bar

-26° to + 200°C (FPM)

**Shut Off Type**

	<b>COUPLING</b>	<b>TST 102.06</b> OV 200 - 01200 OV 157 - 01500 OV 190 - 00370	<b>TST 102.07</b> OV 178 - 01280 OV 157 - 01500 OV 190 - 00420	<b>TST 102.09</b> OV 200 - 01700 OV 200 - 00650 OV 178 - 01875	<b>TST 102.12</b> OV 262 - 02345 OV 262 - 00835 - 88 OV 262 - 02665 - 88
	<b>PLUG</b>	<b>TST 102.06</b> OV 190 - 00370 OV 178 - 01110	<b>TST 102.07</b> OV 190 - 00420 OV 178 - 01110	<b>TST 102.09</b> OV 200 - 00650 OV 178 - 01520	<b>TST 102.12</b> OV 262 - 02025 OV 250 - 00800 - 88

**DN**

TST 102.06 → 6 mm  
TST 102.07 → 7 mm  
TST 102.09 → 9 mm  
TST 102.12 → 12 mm

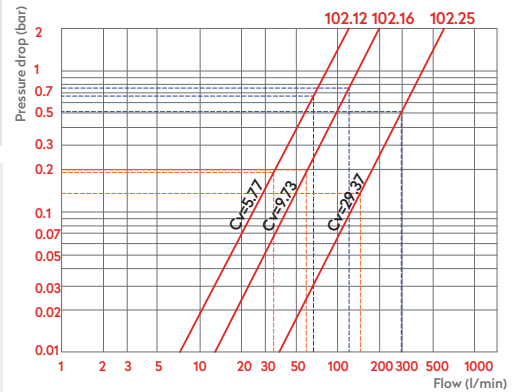

**Options**

EPDM    FFKM please ask    FF

E2    H4    AISI316 Stainless Steel

**Applications**

- Blow Moulding
- Injection Moulding

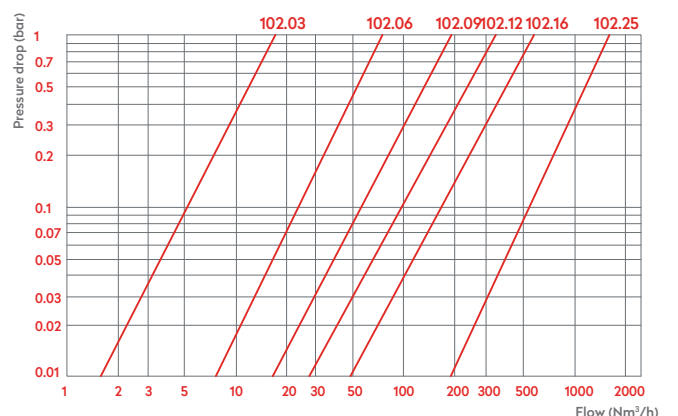
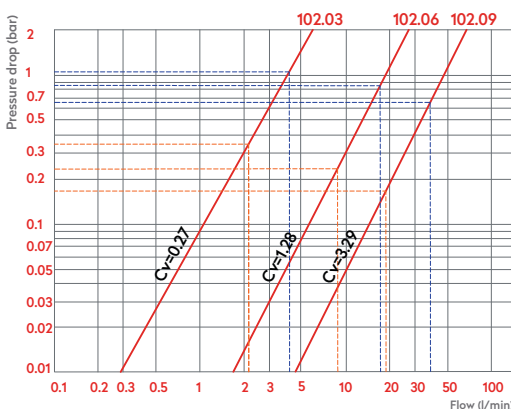

MOULD COOLING COUPLINGS  
KÜHLUNGSELEMENTE FÜR WERKZEUGE

SERIE 102



QUICK COUPLINGS SCHNELLKUPPLUNGEN

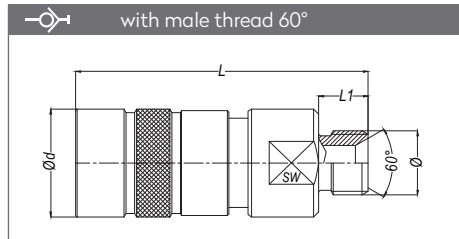

Part No.	DN	Ø	Ød	L	L1	SW
102.06 EGB 13	06	BSP 1/4"	21.8	59.2	10	20
102.07 EGB 13	07	BSP 1/4"	21.8	59.2	10	20
102.09 EGB 17	09	BSP 3/8"	28	77.5	12	24
102.12 EGB 21	12	BSP 1/2"	41.1	109.1	14	27

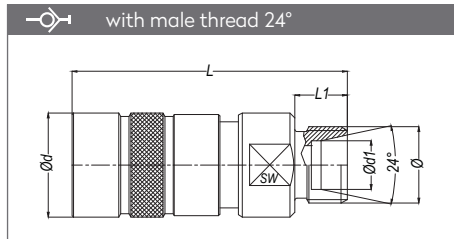

Part No.	DN	Ø	Ød	L	L1	SW
102.06 EGBM 16-10	06	M16x1.5	21.8	58	11	20
102.07 EGBM 16-10	07	M16x1.5	21.8	58	11	20
102.09 EGBM 18-12	09	M18x1.5	28	77.5	12	24
102.12 EGBM 22-12	12	M22x1.5	41	108.1	13	27

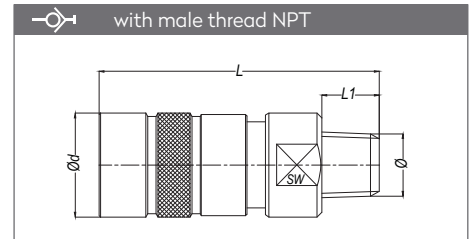

Part No.	DN	Ø	Ød	L	L1	SW
102.06 TGB 13	06	NPT 1/4"	21.8	62.2	13	20
102.07 TGB 13	07	NPT 1/4"	21.8	62.2	13	20
102.09 TGB 17	09	NPT 3/8"	28	78.5	13	24

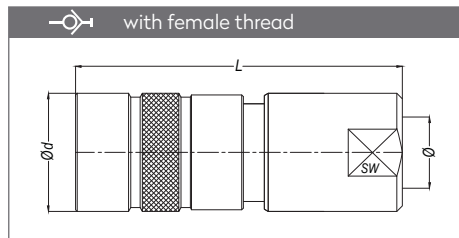

Part No.	DN	Ø	Ød	L	SW
102.06 DGB 13	06	21.8	BSP 1/4"	60.4	20
102.07 DGB 13	07	21.8	BSP 1/4"	60.4	20
102.09 DGB 17	09	28	BSP 3/8"	75.5	24
102.12 DGB 21	12	41	BSP 1/2"	102.9	27
102.06 NGB 13	06	21.8	NPT 1/4"	60.4	20
102.07 NGB 13	07	21.8	NPT 1/4"	60.4	20
102.09 NGB 17	09	28	NPT 3/8"	75.5	24
102.12 NGB 21	12	44	NPT 1/2"	102.9	27

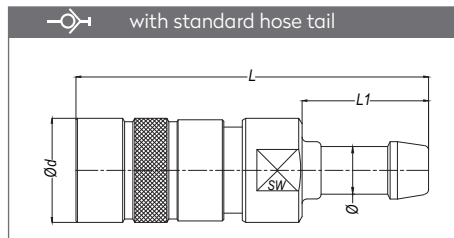

Part No.	DN	Ø	Ød	L	L1	SW
102.06 HGB 10	06	Ø10	21.8	73.9	26.5	20
102.07 HGB 10	07	Ø10	21.8	73.9	26.5	20
102.09 HGB 13	09	Ø13	28	93	27.5	24

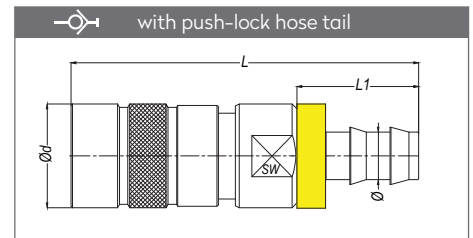

Part No.	DN	Ø	Ød	L	L1	SW
102.06 FGB 10	06	Ø10	21.7	73.4	26	20
102.07 FGB 10	07	Ø10	21.7	73.4	26	20
102.09 FGB 13	09	Ø13	28	93.5	28	24
102.12 FGB 16	12	Ø16	41	124.9	28	36

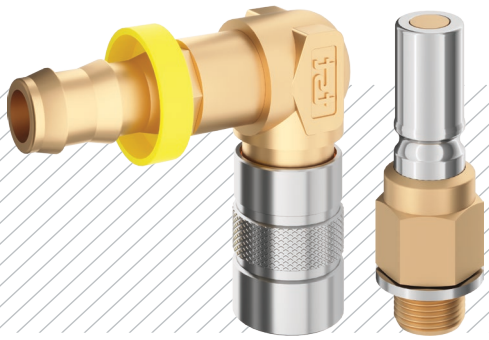

MOULD COOLING COUPLINGS  
KÜHLUNGSELEMENTE FÜR WERKZEUGE

## SERIE 102

### QUICK COUPLINGS SCHNELLKUPPLUNGEN

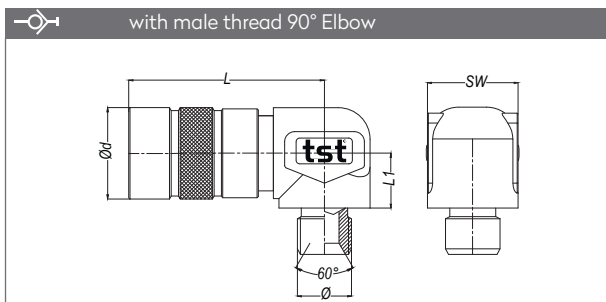

Part No.	DN	Ø	Ød	L	L1	SW
102.06 EGB 13-90	06	BSP 1/4"	21.8	47.5	13.15	21.7
102.07 EGB 13-90	07	BSP 1/4"	21.8	47.5	13.15	21.7
102.09 EGB 17-90	09	BSP 3/8"	28	65.2	15.5	26.8

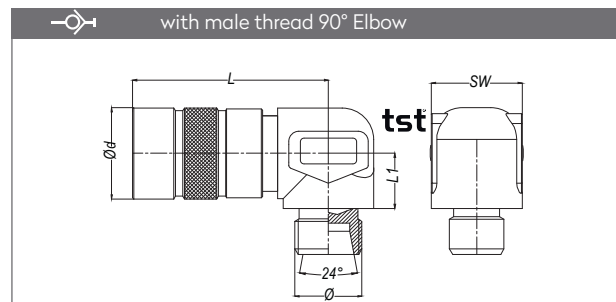

Part No.	DN	Ø	Ød	L	L1	SW
102.06 EGBM 16-10-90	06	M16x1.5	22	47.5	13.15	21.7
102.07 EGBM 16-10-90	07	M16x1.5	22	47.5	13.15	21.7
102.09 EGBM 18-12-90	09	M18x1.5	28	65.2	15.5	26.8

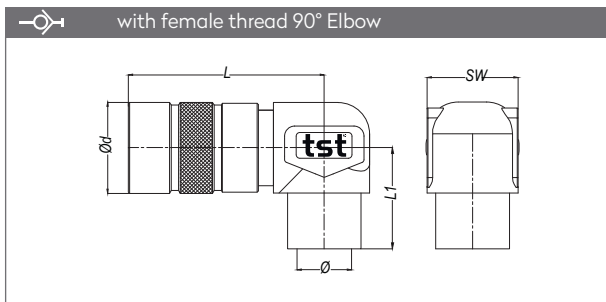

Part No.	DN	Ø	Ød	L	L1	SW
102.06 DGB 13-90	06	BSP 1/4"	21.8	47.5	24.15	21.7
102.07 DGB 13-90	07	BSP 1/4"	21.8	47.5	24.15	21.7
102.09 DGB 17-90	09	BSP 3/8"	28	71	25.7	26.8

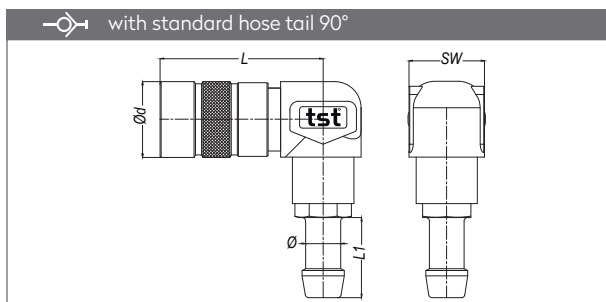

Part No.	DN	Ø	Ød	L	L1	SW
102.06 HGB 10-90	06	Ø10	21.8	47.5	23	21.7
102.07 HGB 10-90	07	Ø10	21.8	47.5	23	21.7
102.09 HGB 13-90	09	Ø13	28	71	27.5	26.8

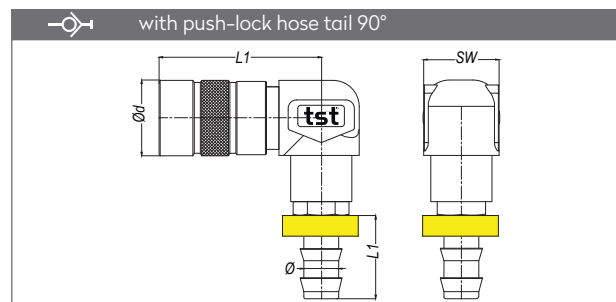

Part No.	DN	Ø	Ød	L	L1	SW
102.06 FGB 10-90	06	Ø10	21.8	47.5	24	21.7
102.07 FGB 10-90	07	Ø10	21.8	47.5	24	21.7
102.09 FGB 13-90	09	Ø13	28	71	28	26.8

MOULD COOLING COUPLINGS

KÜHLUNGSELEMENTE FÜR WERKZEUGE

SERIE 102



PLUGS STECKNIPPEL

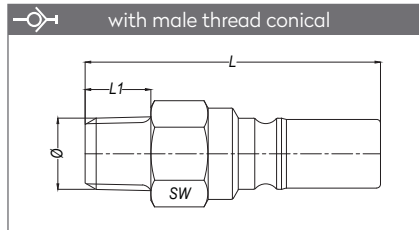

Part No.	DN	Ø	L	L1	SW
102.06 RUB 13	06	BSPT 1/4"	54	12	17
102.06 TUB 13	06	NPT 1/4"	54	12	17
102.07 RUB 13	07	BSPT 1/4"	54	12	17
102.07 TUB 13	07	NPT 1/4"	54	12	17
102.09 RUB 17	09	BSPT 3/8"	67	11	23
102.09 TUB 17	09	NPT 3/8"	69	13	23
102.12 RUB 21	12	BSPT 1/2"	87.9	17	30
102.12 TUB 21	12	NPT 1/2"	87.9	18	30

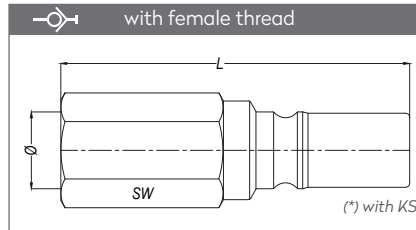

Part No.	DN	Ø	L	SW
102.03 DUB 10	03	BSP 1/8"	45.3	13
102.06 DUB 13*	06	BSP 1/4"	59	17
102.07 DUB 13	07	BSP 1/4"	59	17
102.09 DUB 17*	09	BSP 3/8"	71	23
102.09 NUB 17	09	NPT 3/8"	71	23
102.12 DUB 21	12	BSP 1/2"	89	30
102.12 NUB 21	12	NPT 1/2"	89	30

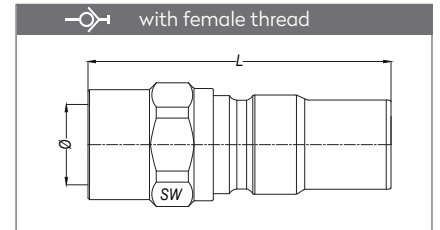

Part No.	DN	Ø	L	SW
102.16 DUB 26	16	BSP 3/4"	102	38
102.16 NUB 26	16	BSP 3/4"	102	38

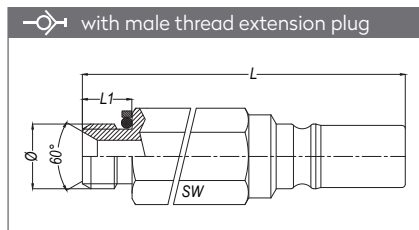

Part No.	DN	Ø	L	L1	SW
102.06 OUB 13x65	06	BSP 1/4"	77	10	17
102.06 OUB 13x80	06	BSP 1/4"	92	10	17
102.06 OUB 13x110	06	BSP 1/4"	122	10	17
102.07 OUB 13x65	07	BSP 1/4"	77	10	17
102.07 OUB 13x80	07	BSP 1/4"	92	10	17
102.07 OUB 13x110	07	BSP 1/4"	122	10	17

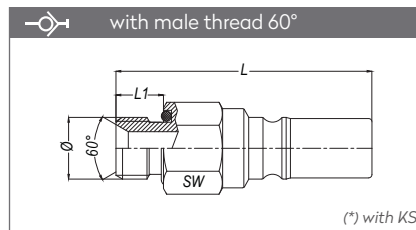

Part No.	DN	Ø	L	L1	SW
102.03 OUB 10	03	BSP 1/8"	39.6	8.2	13
102.06 OUB 13*	06	BSP 1/4"	54	10	17
102.06 OUB 17	06	BSP 3/8"	53	10	21
102.07 OUB 13*	07	BSP 1/4"	54	10	17
102.07 OUB 17	07	BSP 3/8"	53	10	21
102.09 OUB 17	09	BSP 3/8"	65	9	23
102.12 OUB 21	12	BSP 1/2"	84.9	14	30

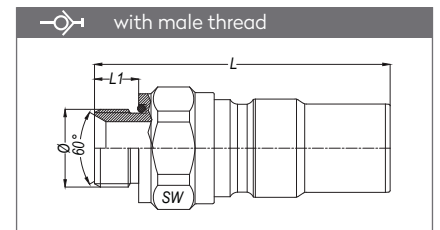

Part No.	DN	Ø	L	L1	SW
102.16 OUB 26	16	BSP 3/4"	100.5	15	38
102.25 OUB 33	25	BSP 1"	124	21	55
102.25 OUB 42	25	BSP 1 1/4"	124	21	55
102.25 DUB 33	25	BSP 1"	126.6	-	55
102.25 DUB 42	25	BSP 1 1/4"	126.6	-	55

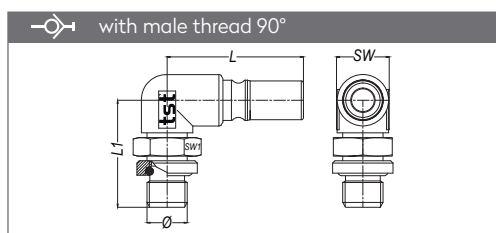

Part No.	DN	Ø	L	L1	SW	SW1
102.06 OUB 13-90	6	BSP 1/4"	50	34.5	17	19
102.07 OUB 13-90	7	BSP 1/4"	50	34.5	17	19

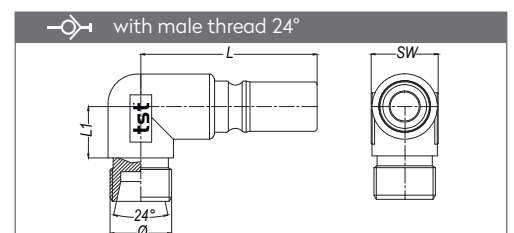

Part No.	DN	Ø	L	L1	SW
102.06 EUBM 16-10-90	6	M16x1.5-Ø10	44.2	13	17

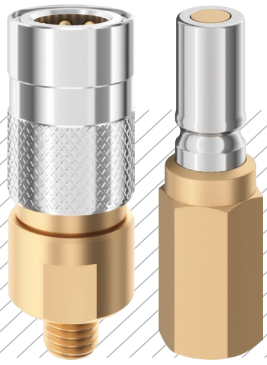

MOULD COOLING COUPLINGS  
KÜHLUNGSELEMENTE FÜR WERKZEUGE

# DN 3-25

## SERIE 102-OH

**Materials**

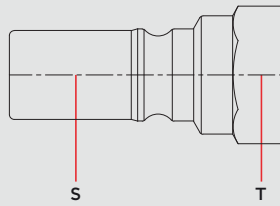
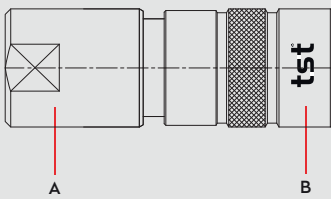

**Material Code**

A = Brass

B = AISI 420 / Chrome Plated

\*Serie 102.12 - 102.16 - 102.25 → AISI420

S = AISI 420

T = Brass



0 - 50 bar



-26° to + 200°C (FPM)

**Shut Off Type**



**COUPLING**  
**PLUG**

COUPLING	TST 102.03-OH	TST 102.06-OH	TST 102.07-OH	TST 102.09-OH	TST 102.12-OH	TST 102.16-OH	TST 102.25-OH
	OV 100 - 00180	OV 178 - 01240	OV 157 - 01300	OV 200 - 01700	OV 262 - 02345	OV 270 - 01410	OV 262 - 02345
	OV 100 - 00870	OV 190 - 00370	OV 157 - 01500	OV 200 - 00650	OV 262 - 00835-88	OV 353 - 03000	OV 353 - 04345
	OV 120 - 00600	OV 157 - 01500	OV 190 - 00420	OV 178 - 01875	OV 262 - 02665-88	OV 262 - 03615	OV 262 - 04890
PLUG	TST 102.03	TST 102.06	TST 102.07	TST 102.09	TST 102.12	TST 102.16	TST 102.25
	OV 100 - 00180	OV 190 - 00370	OV 190 - 00420	OV 200 - 00650	OV 262 - 02025	OV 262 - 01435	OV 262 - 02345
	OV 120 - 00600	OV 178 - 01110	OV 178 - 01110	OV 178 - 01520	OV 250 - 00800-88	OV 262 - 02840	OV 262 - 04255

**DN**

TST 102.03 → 3 mm  
TST 102.06 → 6 mm  
TST 102.07 → 7 mm  
TST 102.09 → 9 mm  
TST 102.12 → 12 mm  
TST 102.16 → 16 mm  
TST 102.25 → 25 mm

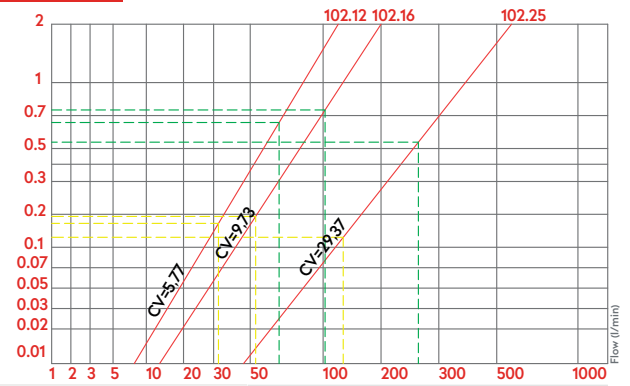
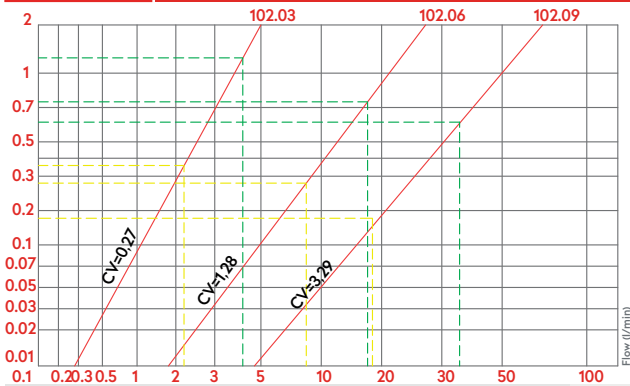

**Options**

EPDM

FFKM  
please ask

E2

AISI303  
Serie 102-H4

**Applications**

- Blow Moulding
- Injection Moulding

**Compatible with**

RECTUS

206, 209

MOULD COOLING COUPLINGS

KÜHLUNGSELEMENTE FÜR WERKZEUGE

SERIE 102-OH



QUICK COUPLINGS SCHNELLKUPPLUNGEN

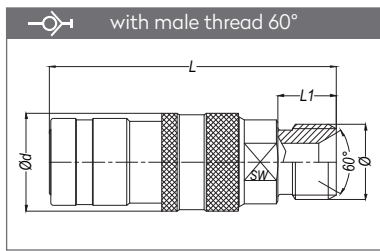

Part No.	DN	Ø	Ød	L	L1	SW
102.03 EGB 13-OH	03	BSP 1/4"	17	49.5	10	13

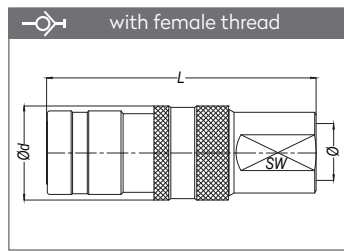

Part No.	DN	Ø	Ød	L	SW
102.03 DGB 10-OH	03	BSP 1/8"	17	48.5	13

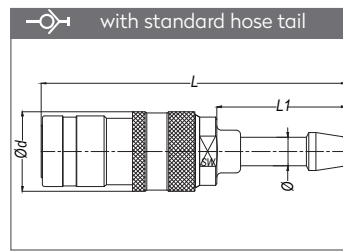

Part No.	DN	Ø	Ød	L	L1	SW
102.03 HGB 06-OH	03	6	17	64.85	27.5	13

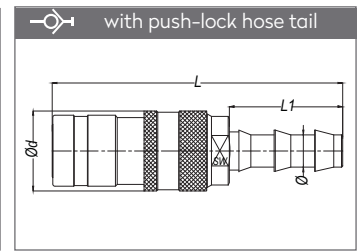

Part No.	DN	Ø	Ød	L	L1	SW
102.03 FGB 06-OH	03	06	17	61.5	24	13
102.06 FGB 10-OH	03	10	17	63.5	26	13

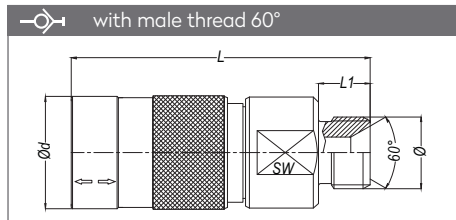

Part No.	DN	Ø	Ød	L	L1	SW
102.06 EGB 13-OH	06	BSP 1/4"	22	58.4	10	20
102.07 EGB 13-OH	07	BSP 1/4"	22	58.4	10	20
102.09 EGB 17-OH	09	BSP 3/8"	29.2	77.9	12	24
102.12 EGB 21-OH	12	BSP 1/2"	44	106.9	12	30

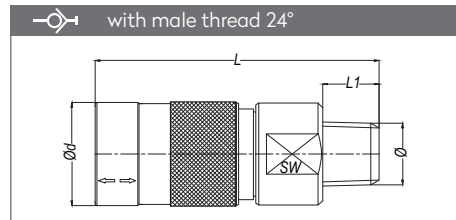

Part No.	DN	Ø	Ød	L	L1	SW
102.06 EGBM 16-10-OH	06	M16x1.5	22	61.1	11	20
102.07 EGBM 16-10-OH	07	M16x1.5	22	61.1	11	20
102.09 EGBM 18-12-OH	09	M18x1.5	29.2	77.9	12	24
102.12 EGBM 20-14-OH	12	M20x1.5	44	105.9	13	27

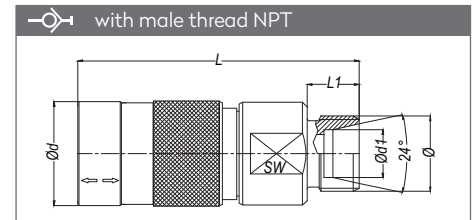

Part No.	DN	Ø	Ød	L	L1	SW
102.06 TGB 13-OH	06	NPT 1/4"	22	60.9	13	20
102.07 TGB 13-OH	07	NPT 1/4"	22	60.9	13	20
102.09 TGB 17-OH	09	NPT 3/8"	29.2	61.9	13	24

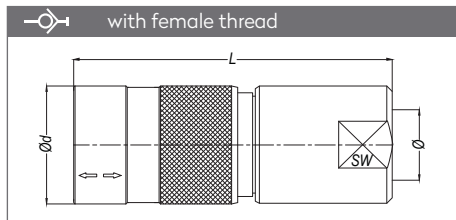

Part No.	DN	Ø	Ød	L	SW
102.06 DGB 13-OH	06	BSP 1/4"	22	59.6	20
102.07 DGB 13-OH	07	BSP 1/4"	22	59.6	20
102.09 DGB 17-OH	09	BSP 3/8"	29.2	76.5	24
102.12 DGB 21-OH	12	BSP 1/2"	44	100.9	27

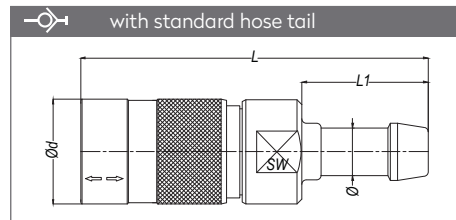

Part No.	DN	Ø	Ød	L	L1	SW
102.06 HGB 10-OH	06	Ø10	22	82	26.5	20
102.07 HGB 10-OH	07	Ø10	22	82	26.5	20
102.09 HGB 13-OH	09	Ø13	28	92.5	27.5	24

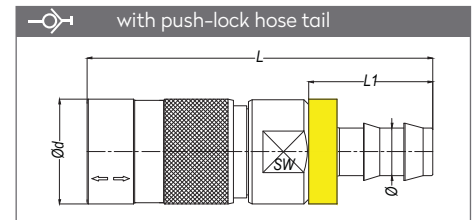

Part No.	DN	Ø	Ød	L	L1	SW
102.06 FGB 10-OH	06	Ø10	22	77.2	28	20
102.07 FGB 10-OH	07	Ø10	22	77.2	28	20
102.09 FGB 13-OH	09	Ø13	29.2	93.5	28	24
102.12 FGB 16-OH	12	Ø16	44	132.9	28	27

Part No.	DN	Ø	Ød	L	SW
102.06 NGB 13-OH	06	NPT 1/4"	22	59.6	20
102.07 NGB 13-OH	07	NPT 1/4"	22	59.6	20
102.09 NGB 17-OH	09	NPT 3/8"	29.2	76.5	24
102.12 NGB 21-OH	12	NPT 1/2"	44	100.9	27

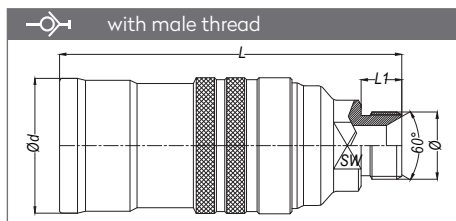

Part No.	DN	Ø	Ød	L	L1	SW
102.16 EGB 26-OH	16	BSP 3/4"	53.6	134.8	16	32

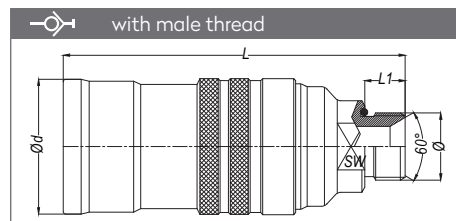

Part No.	DN	Ø	Ød	L	L1	SW
102.16 OGB 26-OH	16	BSP 3/4"	53.6	134.8	16	32

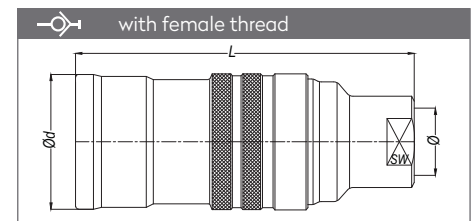

Part No.	DN	Ø	Ød	L	SW
102.16 DGB 26-OH	16	BSP 3/4"	53.6	133.5	32
102.16 NGB 26-OH	16	BSP 3/4"	53.6	133.5	32
102.25 DGB 33-OH	25	BSP 1"	66.5	148.1	55
102.25 DGB 42-OH	25	BSP 1 1/4"	66.5	148.1	55



MOULD COOLING COUPLINGS  
KÜHLUNGSELEMENTE FÜR WERKZEUGE

## SERIE 102-OH

### QUICK COUPLINGS SCHNELLKUPPLUNGEN

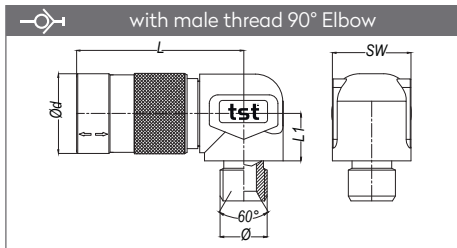

Part No.	DN	Ø	Ød	L	L1	SW
102.06 EGB 13-90-OH	06	BSP 1/4"	22	47	13.15	21.7
102.07 EGB 13-90-OH	07	BSP 1/4"	22	47	13.15	21.7
102.09 EGB 17-90-OH	09	BSP 3/8"	29.2	71	15.5	26.8

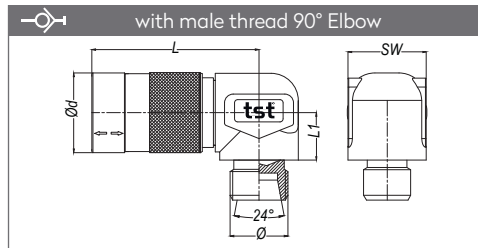

Part No.	DN	Ø	Ød	L	L1	SW
102.06 EGBM 16-10-90-OH	06	M16x1.5	22	47	13.15	21.7
102.07 EGBM 16-10-90-OH	07	M16x1.5	22	47	13.15	21.7
102.09 EGBM 18-12-90-OH	09	M18x1.5	29.2	71	15.5	26.8

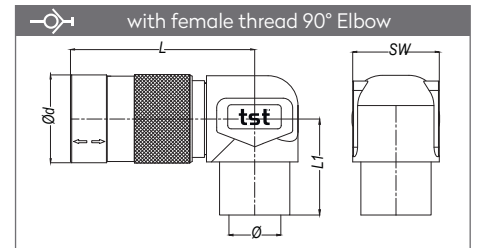

Part No.	DN	Ø	Ød	L	L1	SW
102.06 DGB 13-90-OH	06	BSP 1/4"	22	47	24.15	21.7
102.07 DGB 13-90-OH	07	BSP 1/4"	22	47	24.15	21.7
102.09 DGB 17-90-OH	09	BSP 3/8"	29.2	71	25.7	26.8

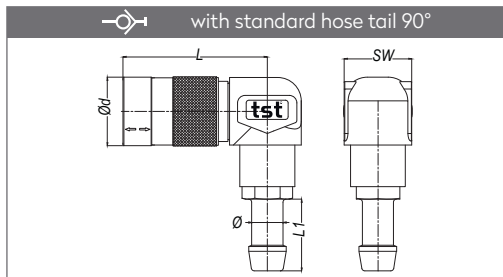

Part No.	DN	Ø	Ød	L	L1	SW
102.06 HGB 10-90-OH	06	Ø10	22	47	23	21.7
102.07 HGB 10-90-OH	07	Ø10	22	47	23	21.7
102.09 HGB 13-90-OH	09	Ø13	31	71	27.5	26.8

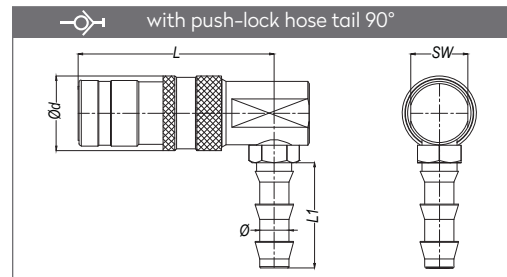

Part No.	DN	Ø	Ød	L	L1	SW
102.06 FGB 10-90-OH	06	Ø10	22	47	24	21.7
102.07 FGB 10-90-OH	07	Ø10	22	47	24	21.7
102.09 FGB 13-90-OH	09	Ø13	31	71	28	26.8

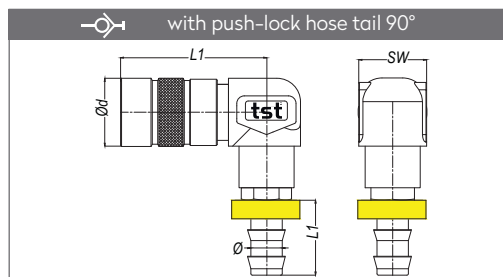

Part No.	DN	Ø	Ød	L	L1	SW
102.03 FGB 06-90-OH	03	06	17	52.7	24	13

MOULD COOLING COUPLINGS  
KÜHLUNGSELEMENTE FÜR WERKZEUGE

**SERIE 102-OH**

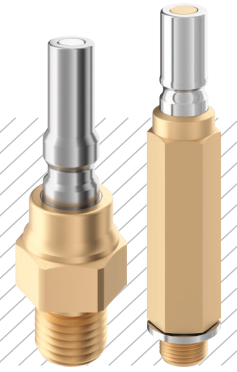

**PLUGS STECKNIPPEL**

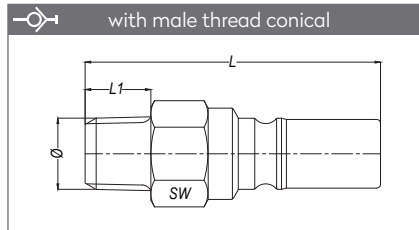

Part No.	DN	Ø	L	L1	SW
102.06 RUB 13	06	BSPT 1/4"	54	12	17
102.06 TUB 13	06	NPT 1/4"	54	12	17
102.07 RUB 13	07	BSPT 1/4"	54	12	17
102.07 TUB 13	07	NPT 1/4"	54	12	17
102.09 RUB 17	09	BSPT 3/8"	67	11	23
102.09 TUB 17	09	NPT 3/8"	69	13	23
102.12 RUB 21	12	BSPT 1/2"	87.9	17	30
102.12 TUB 21	12	NPT 1/2"	87.9	18	30

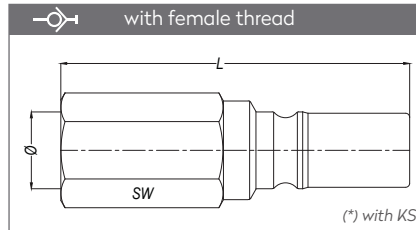

Part No.	DN	Ø	L	SW
102.03 DUB 10	03	BSP 1/8"	45.3	13
102.06 DUB 13*	06	BSP 1/4"	59	17
102.07 DUB 13	07	BSP 1/4"	59	17
102.09 DUB 17*	09	BSP 3/8"	71	23
102.09 NUB 17	09	NPT 3/8"	71	23
102.12 DUB 21	12	BSP 1/2"	89	30
102.12 NUB 21	12	NPT 1/2"	89	30

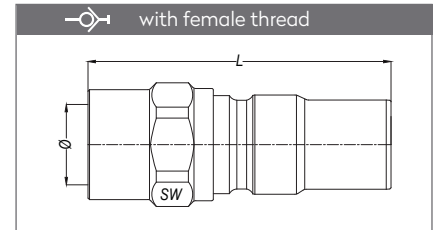

Part No.	DN	Ø	L	SW
102.16 DUB 26	16	BSP 3/4"	102	38
102.16 NUB 26	16	BSP 3/4"	102	38

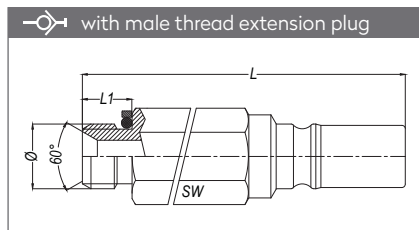

Part No.	DN	Ø	L	L1	SW
102.06 OUB 13x65	06	BSP 1/4"	77	10	17
102.06 OUB 13x80	06	BSP 1/4"	92	10	17
102.06 OUB 13x110	06	BSP 1/4"	122	10	17
102.07 OUB 13x65	07	BSP 1/4"	77	10	17
102.07 OUB 13x80	07	BSP 1/4"	92	10	17
102.07 OUB 13x110	07	BSP 1/4"	122	10	17

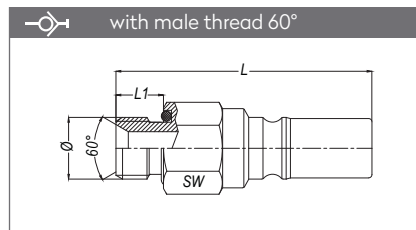

Part No.	DN	Ø	L	L1	SW
102.03 OUB 10	03	BSP 1/8"	39.6	8.2	13
102.06 OUB 13	06	BSP 1/4"	54	10	17
102.06 OUB 17	06	BSP 3/8"	53	10	21
102.07 OUB 13	07	BSP 1/4"	54	10	17
102.07 OUB 17	07	BSP 3/8"	53	10	21
102.09 OUB 17	09	BSP 3/8"	65	9	23
102.12 OUB 21	12	BSP 1/2"	84.9	14	30

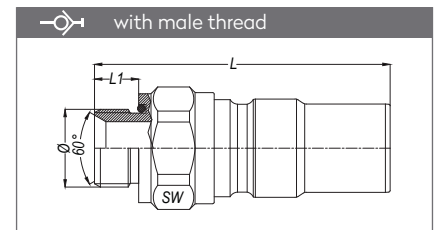

Part No.	DN	Ø	L	L1	SW
102.16 OUB 26	16	BSP 3/4"	100.5	15	38
102.25 OUB 33	25	BSP 1"	124	21	55
102.25 OUB 42	25	BSP 1 1/4"	124	21	55
102.25 DUB 33	25	BSP 1"	126.6	-	55
102.25 DUB 42	25	BSP 1 1/4"	126.6	-	55

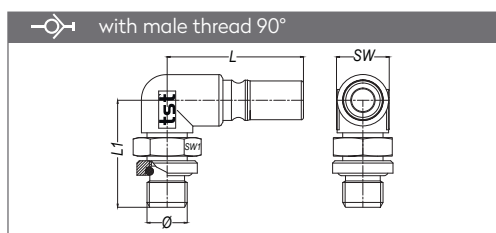

Part No.	DN	Ø	L	L1	SW	SW1
102.06 OUB 13-90	6	BSP 1/4"	50	34.5	17	19
102.07 OUB 13-90	7	BSP 1/4"	50	34.5	17	19

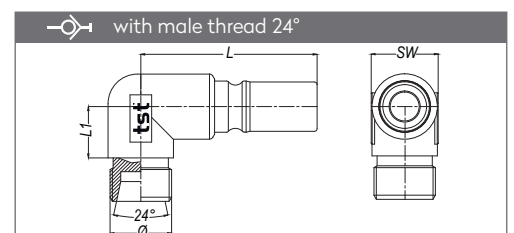

Part No.	DN	Ø	L	L1	SW
102.06 EUBM 16-10-90	6	M16x1.5-Ø10	44.2	13	17