

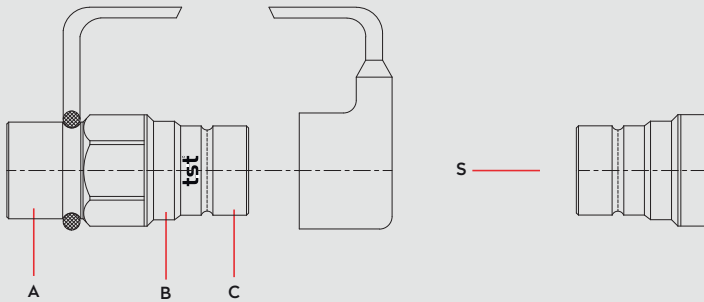

HYDRAULIC COUPLINGS
HYDRAULISCHE KUPPLUNGEN
DN 6-16
SERIE 124

Materials



Material Code

A = Steel + Zinc

B = Steel + Zinc

C = AISI420

S = AISI420



TST 124.06 → 0 - 450 bar
TST 124.08 → 0 - 450 bar
TST 124.12 → 0 - 350 bar
TST 124.16 → 0 - 350 bar



-26° to + 200°C (FPM)

Shut Off Type



Residual Pressure	max. PD (optional)				
	Serie	124.06	124.08	124.12	124.16
	Coupling	-	150	150	150
Plug	40	90	35	60	

DN

TST 124.06 → 6 mm
TST 124.08 → 8 mm
TST 124.12 → 12 mm
TST 124.16 → 16 mm

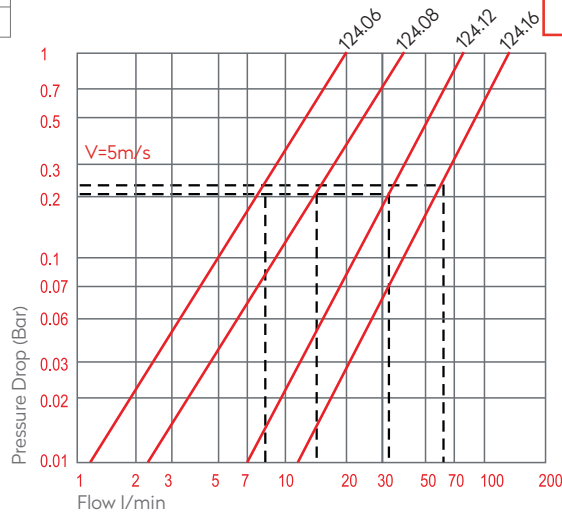

Options	Applications	Compatible with
<div style="display: flex; justify-content: space-around;"> <div style="border: 1px solid black; padding: 5px; background-color: #f00; color: white;">FFKM 124.16</div> <div style="border: 1px solid black; padding: 5px; background-color: #f00; color: white;">PD</div> <div style="border: 1px solid black; padding: 5px; background-color: #f00; color: white;">Id. Ring</div> </div>	<ul style="list-style-type: none"> • High pressure • Hydraulic circuits 	

HYDRAULIC COUPLINGS
HYDRAULISCHE KUPPLUNGEN

SERIE 124

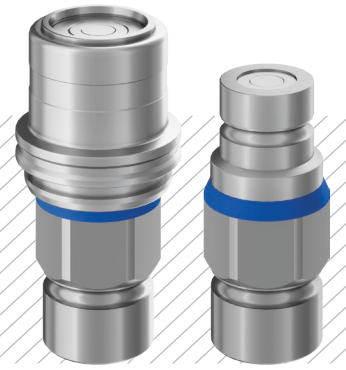

QUICK COUPLINGS SCHNELLKUPPLUNGEN

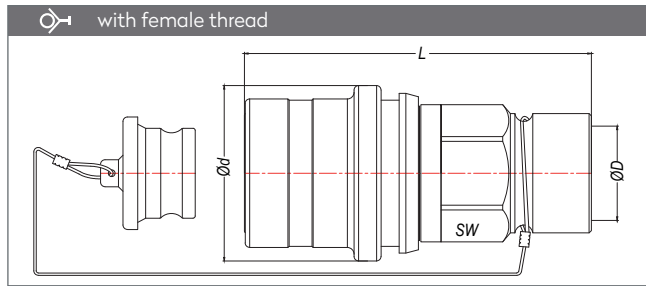

Part no.	DN	Ø	Ød	L	SW
124.06 DGB 17	6	BSP 3/8"	39	76.9	27
124.06 NGB 17	6	NPT 3/8"	39	76.9	27
124.08 DGB 21	8	BSP 1/2"	47	90	32
124.08 NGB 21	8	NPT 1/2"	47	90	32
124.12 DGB 26	12	BSP 3/4"	49	103.1	41
124.12 NGB 26	12	NPT 3/4"	49	103.1	41
124.16 DGB 33	16	BSP 1"	69	116.5	50
124.16 NGB 33	16	NPT 1"	69	116.5	50

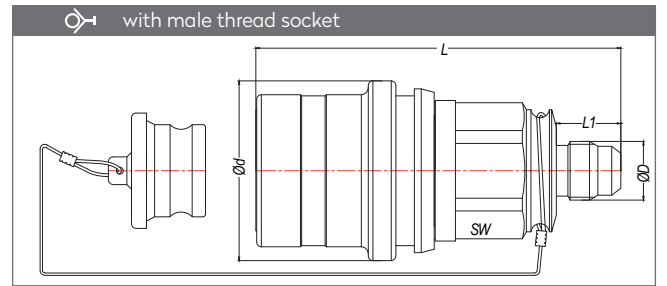

Part no.	DN	Ø	Ød	L	L1	SW
124.06 JGB 13-74	6	UNF 1/2" 20 - Ø5	39	79.2	14	27
124.08 JGB 19-74	8	UNF 3/4" 16 - Ø8	47	91	17	32
124.12 JGB 22-74	12	UNF 7/8" 14 - Ø10	49	105.6	19.5	41
124.16 JGB 27-74	16	UN1- 1/16-12 - Ø12	69	126.1	22	50

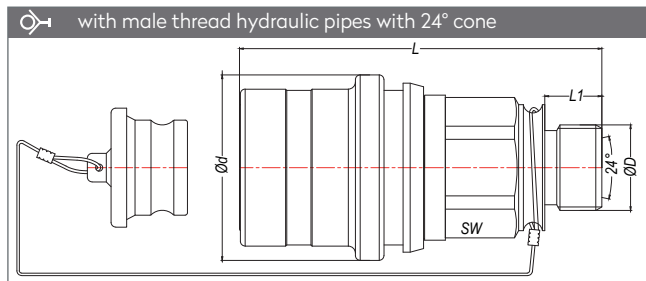

Part no.	DN	Ø	Ød	L	L1	SW
124.06 EGBM 18-10	6	M18x1.5 Ø10 (OD)	39	76.2	12	27
124.08 EGBM 20-12	8	M20x1.5 Ø12 (OD)	47	80.7	12	32
124.12 EGBM 24-16	12	M24x1.5 Ø16 (OD)	49	105.6	16	41
124.16 EGBM 30-20	16	M30x2 Ø20 (OD)	69	121.1	16	50

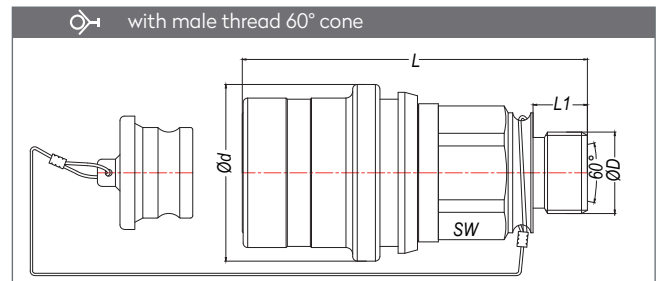

Part no.	DN	Ø	Ød	L	L1	SW
124.06 EGB 17-60	6	BSP 3/8"	39	67.6	12	27
124.08 EGB 21-60	8	BSP 1/2"	47	82.7	14	32
124.12 EGB 26-60	12	BSP 3/4"	49	108.1	18.5	41
124.16 EGB 26-60	16	BSP 3/4"	69	121.1	16	50

HYDRAULIC COUPLINGS
 HYDRAULISCHE KUPPLUNGEN

SERIE 124

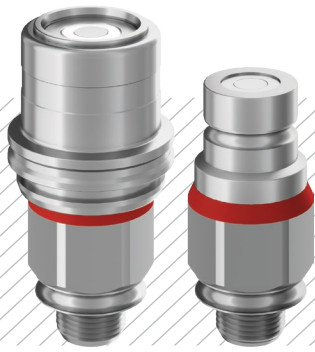

PLUGS STECKNIPPEL

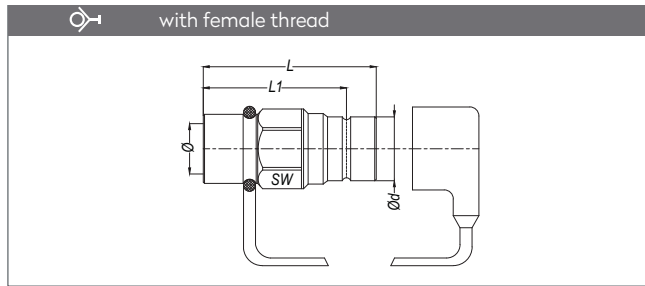

Part no.	DN	Ø	Ød	L	L1	SW
124.06 DUB 17	6	BSP 3/8"	30.5	62.1	51.6	27
124.06 NUB 17	6	NPT 3/8"	30.5	63.1	52.6	27
124.08 DUB 21	8	BSP 1/2"	35.5	73	60.85	32
124.08 NUB 21	8	NPT 1/2"	35.5	70	57.85	32
124.12 DUB 26	12	BSP 3/4"	46	84.3	68.15	41
124.12 NUB 26	12	NPT 3/4"	46	84.3	68.15	41
124.16 DUB 26	16	BSP 3/4"	56.5	94.5	73	50
124.16 NUB 26	16	NPT 3/4"	56.5	94.5	73	50

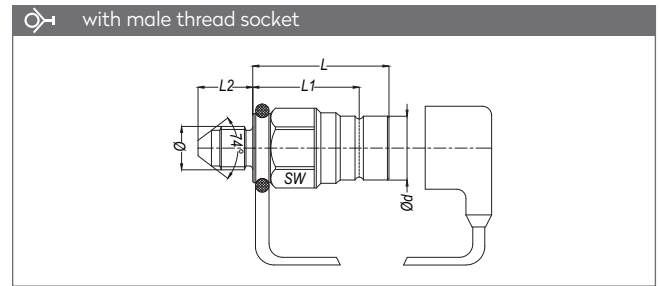

Part no.	DN	Ø	Ød	L	L1	L2	SW
124.06 JUB 13-74	6	UNF 1/2" 20 - Ø5	30.5	50.6	34.6	14	27
124.08 JUB 19-74	8	UNF 3/4" 16 - Ø8	35.5	57.5	45.35	17	32
124.12 JUB 22-74	12	UNF 7/8" 14 - Ø10	46	70.8	54.65	19.5	41
124.16 JUB 27-74	16	UN 1- 1/16-12- Ø12	56.5	83.1	61.6	22	50

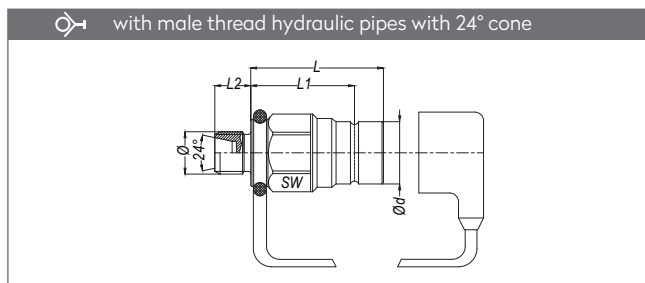

Part no.	DN	Ø	Ød	L	L1	L2	SW
124.06 EUBM 18-10	6	M18x1.5 Ø10 (OD)	30.5	49.6	39.1	12	27
124.08 EUBM 20-12	8	M20x1.5 Ø12 (OD)	35.5	58	45.85	12	32
124.12 EUBM 24-16	12	M24x1.5 Ø16 (OD)	46	70.8	54.65	14	41
124.16 EUBM 30-20	16	M30x2 Ø20 (OD)	56.5	83.1	61.6	16	50

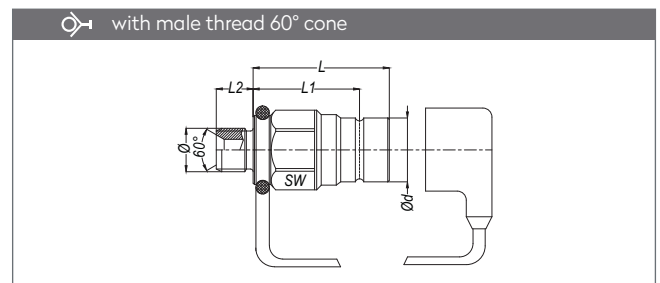

Part no.	DN	Ø	Ød	L	L1	L2	SW
124.06 EUB 17-60	6	BSP 3/8"	30.5	49.6	39.1	12	27
124.08 EUB 21-60	8	BSP 1/2"	35.5	58	45.85	14	32
124.12 EUB 26-60	12	BSP 3/4"	46	70.8	54.65	18.5	41
124.16 EUB 26-60	16	BSP 3/4"	56.5	83.1	61.6	16	50

HYDRAULIC COUPLINGS
HYDRAULISCHE KUPPLUNGEN

SERIE 124

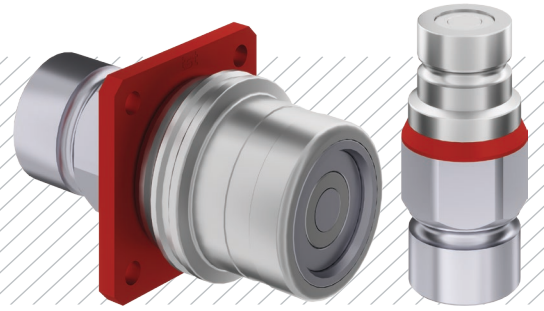

QUICK COUPLINGS SCHNELLKUPPLUNGEN

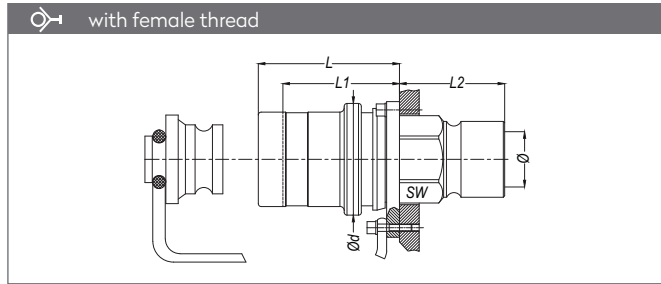

Part no.	DN	Ø	Ød	L	L1	L2	SW
1241.06 DGB 17	6	BSP 3/8"	39	44	36	32.9	27
1241.06 NGB 17	6	NPT 3/8"	39	44	36	32.9	27
1241.08 DGB 21	8	BSP 1/2"	47	50.1	41.5	39.9	32
1241.08 NGB 21	8	NPT 1/2"	47	50.1	41.5	36.9	32
1241.12 DGB 26	12	BSP 3/4"	59	61.2	51.6	44.9	41
1241.12 NGB 26	12	NPT 3/4"	59	61.2	51.6	44.9	41
1241.16 DGB 26	16	BSP 3/4"	69	71.1	60.6	45.4	50
1241.16 NGB 26	16	NPT 3/4"	69	71.1	60.6	45.4	50

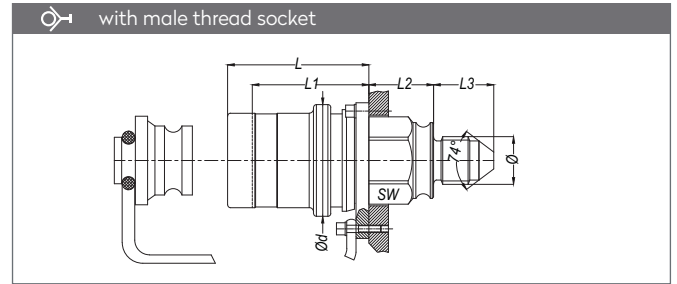

Part no.	DN	Ø	Ød	L	L1	L2	L3	SW
1241.06 JGB 13-74	6	UNF 1/2" 20 - Ø5	39	44	36	13.4	14	27
1241.08 JGB 19-74	8	UNF 3/4" 16 - Ø8	47	50.1	41.5	24.9	16.5	32
1241.12 JGB 22-74	12	UNF 7/8" 14 - Ø10	59	61.2	51.6	9.1	19.3	41
1241.16 JGB 27-74	16	UNF 1 1/16-12" 12 - Ø12	69	71.1	60.6	33.9	22	50

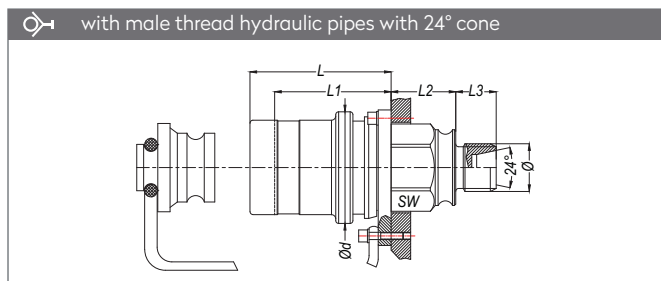

Part no.	DN	Ø	Ød	L	L1	L2	L3	SW
1241.06 EGBM 18-10	6	M18x1.5 Ø10 (OD)	39	44	36	12.4	12	27
1241.08 EGBM 20-12	8	M20x1.5 Ø12 (OD)	47	50.1	41.5	24.9	12	32
1241.12 EGBM 24-16	12	M24x1.5 Ø16 (OD)	59	61.2	51.6	14.4	14	41
1241.16 EGBM 30-20	16	M30x2 Ø20 (OD)	69	71.1	60.6	33.9	16	50

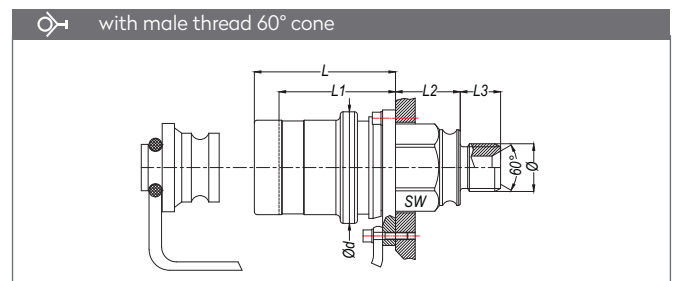

Part no.	DN	Ø	Ød	L	L1	L2	L3	SW
1241.06 EGB 17-60	6	BSP 3/8"	39	44	36	12.4	12	27
1241.08 EGB 21-60	8	BSP 1/2"	47	50.1	41.5	24.9	14	32
1241.12 EGB 26-60	12	BSP 3/4"	59	61.2	51.6	9.9	18.5	41
1241.16 EGB 26-60	16	BSP 3/4"	69	71.1	60.6	33.9	16	50

HYDRAULIC COUPLINGS
 HYDRAULISCHE KUPPLUNGEN

SERIE 124

PLUGS STECKNIPPEL

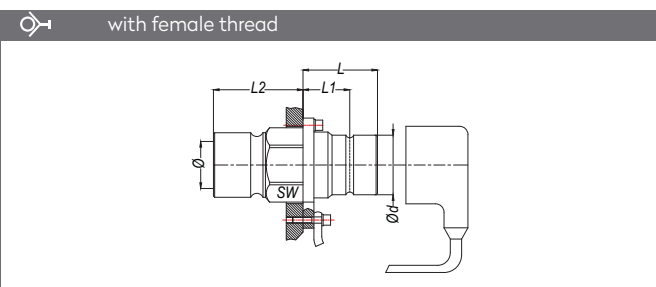

Part no.	DN	Ø	Ød	L	L1	L2	SW
1241.06 DUB 17	6	BSP 3/8"	29.5	29.2	14.2	33	27
1241.06 NUB 17	6	NPT 3/8"	29.5	29.2	14.2	34	27
1241.08 DUB 21	8	BSP 1/2"	35.5	33.1	20.7	39.9	32
1241.08 NUB 21	8	NPT 1/2"	35.5	33.1	20.7	36.9	32
1241.12 DUB 26	12	BSP 3/4"	46	42.4	26.3	44.9	41
1241.12 NUB 26	12	NPT 3/4"	46	42.4	26.3	44.9	41
1241.16 DUB 26	16	BSP 3/4"	56.5	46.1	27.6	48.4	50
1241.16 NUB 26	16	NPT 3/4"	56.5	46.1	27.6	48.4	50

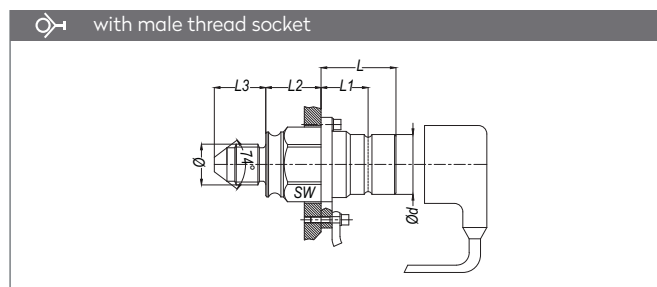

Part no.	DN	Ø	Ød	L	L1	L2	L3	SW
1241.06 JUB 13-74	6	UNF 1/2" 20 - Ø5	29.5	29.2	18.7	21.4	14	27
1241.08 JUB 19-74	8	UNF 3/4" 16 - Ø8	35.5	33.1	20.95	24.4	17	32
1241.12 JUB 22-74	12	UNF 7/8" 14 - Ø10	46	42.4	26.25	28.4	19.5	41
1241.16 JUB 27-74	16	UN 1 1/16-12 - Ø12	56.5	49.1	27.6	34	22	50

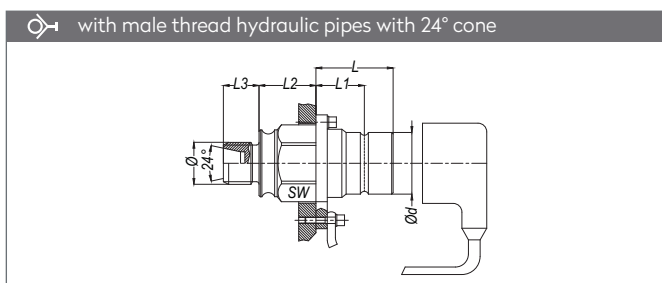

Part no.	DN	Ø	Ød	L	L1	L2	L3	SW
1241.06 EUBM 18-10	6	M18x1.5 Ø10 (OD)	29.5	29.2	18.7	20.4	12	27
1241.08 EUBM 20-12	8	M20x1.5 Ø12 (OD)	35.5	33.1	20.95	24.9	12	32
1241.12 EUBM 24-16	12	M24x1.5 Ø16 (OD)	46	42.4	26.25	28.4	14	41
1241.16 EUBM 30-20	16	M30x2 Ø20 (OD)	56.5	49.1	27.6	34	16	50

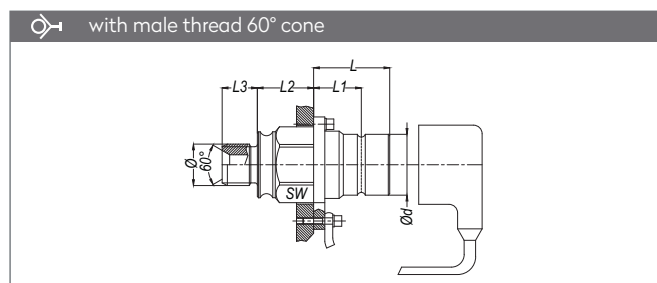

Part no.	DN	Ø	Ød	L	L1	L2	L3	SW
1241.06 EUB 17-60	6	BSP 3/8"	29.5	29.2	18.7	20.4	12	27
1241.08 EUB 21-60	8	BSP 1/2"	35.5	33.1	20.95	24.9	14	32
1241.12 EUB 26-60	12	BSP 3/4"	46	42.4	26.25	28.4	18.5	41
1241.16 EUB 26-60	16	BSP 3/4"	56.5	49.1	27.6	34	16	50

SERIE 124



QUICK COUPLINGS SCHNELLKUPPLUNGEN

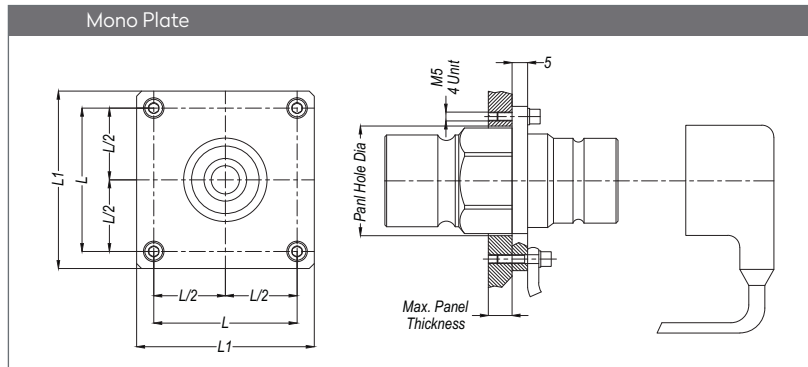
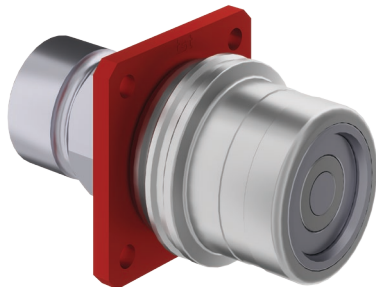
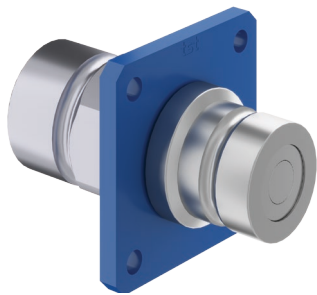

Serie	Max. Panel Thickness	Panel Hole	L	L1	A
124.06	8	32	39	50	5
124.08	10	37.5	40	53	5
124.12	10	48	52	65	8
124.16	10	58	57	70	8

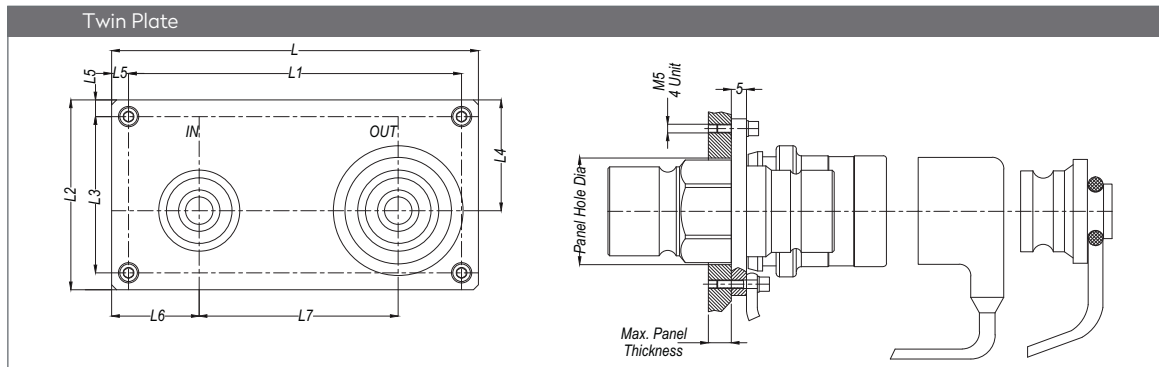

Serie	Max. Panel Thickness	Panel Hole	L	L1	L2	L3	L4	L5	L6	L7	A
124.06	8	32	84	95	53	42	29.5	5.5	23.5	48	5
124.08	10	37.5	97	110	63	50	36.5	6.5	26	58	5
124.12	10	48	122	135	75	62	42.5	6.5	32.5	70	8
124.16	10	58	137	150	80	67	45	6.5	35	80	8